

Übersicht - Akustikdeckenprogramm

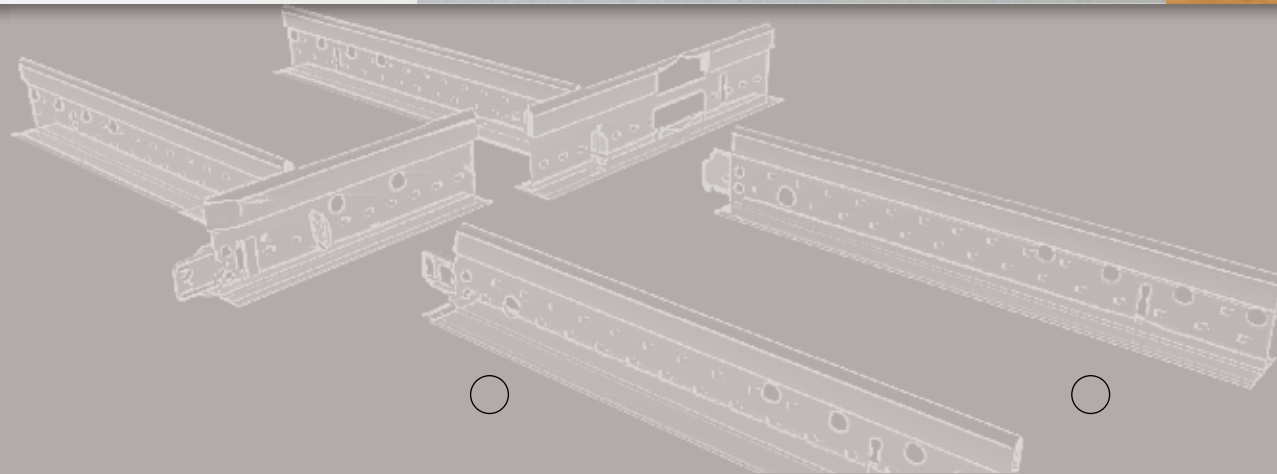

Wie **benutzen** Sie diesen Katalog?

Diese Broschüre enthält die **Armstrong Standard Produktreihen** aus:

- Mineralfaser
- Metall
- Holz
- Canopy-Deckensegel
- Unterkonstruktionssysteme

Um Ihnen bei der Suche nach den für Sie geeigneten Produkten behilflich zu sein, ist der Inhalt dieses Kataloges nach unterschiedlichen Kriterien aufgelistet:

■ Nach Produkteigenschaften:

Sie können in diesem Kapitel die Decke finden, die Ihren Anforderungen entspricht (Akustik, Brandschutz, Lichtreflexion, Abwaschbarkeit oder Hygiene)

■ Nach Oberflächenstruktur und Material:

In dieser Abschnitt finden Sie die richtige Oberflächenstruktur für Ihre Unterdecke.

	Recyclinganteil (%)	Lichtreflexion (%)	α_w	NRC	D_{nfw}	Brandschutz	% RH	Quadrat- und Rechteckplatten					Langfeldplatten				
								T24			T15		T24	Halbverdecktes Unterkonstruktionssystem			
								Board	Tegular	Vector	MicroLook	MicroLook BE	Board	SL2	K2C2		
Spezielle Einsatzbereiche	Bioguard Plain (ISO 5)	52	87	0,15(L)	0,15	37*	A2-s1, d0	95	■ ■ ■	■		■					
	Bioguard Acoustic (ISO 5)	45	85	0,60(H)	0,60	36	A2-s1, d0	95	■ ■ ■	■		■					
	Metal Bioguard (ISO 3)	30	≤ 85	≤ 0,65**	≤ 0,60**	40*	A2-s1, d0	≤ 100	■ ■ ■ (1)	■ ■ ■ ■	■	■ ■ ■ ■			■ ■ ■ ■ (1) (2)		
	Clean Room FL (ISO 5)	--	78	0,15	0,10	36*	A2-s1, d0	95	■ ■ ■								
	Parafon Hygien (ISO 5)	--	82	0,95	0,95	--	A2-s1, d0	95	■ ■ ■								
	Hydroboard	--	82	0,95	0,90	22*	A1	≤ 100	■ ■ ■								
	Newtonone	--	84	0,10(L)	0,10	37*	A2-s1, d0	100	■								
	Ceramaguard	38	79	0,55(MH)	0,60	39*	A1	100	■ ■ ■								

	Recyclinganteil (%)	Lichtreflexion (%)	α_w	NRC	D_{nfw}	Brandschutz	% RH	Oberflächenstruktur			Material						
								konkav	konvex	flach	Board	Tegular	Vector	MicroLook	MicroLook BE	Board	SL2
Canopy-Deckensegel	Ultima Canopy	44	85	**	**	N/A	A2-s1, d0		70	■	■						
	Metal Canopy	30	85	**	**	N/A	B-s2, d0	90	■	■	■						
	Axiom Canopy	25	≤ 90	**	**	N/A	--	N/A				■ (3)					

■ 600 x 600 mm oder äquivalent. ■ 600 x 1200 mm, 300 x 1200 mm oder äquivalent.

*Dncw Leistung. **Siehe Produktseite oder kontaktieren Sie uns für weitere Informationen.

(1) Gleiche Abmessung für die Clip-in Produktreihe. (2) HOOK-ON Metalllangfeldplatten. (3) Unterschiedliche Abmessungen erhältlich.

Aktuelle Informationen finden Sie unter www.armstrong-decken.de

									Quadrat- & Rechteckplatten					Langfeldplatten		
		Recyclinganteil (%)	Lichtreflexion (%)	α_w	NRC	D_{nfw}	Brandschutz	% RH	T24			T15		T24	Halbverdecktes Unterkonstruktionssystem	
									Board	Tegular	Vector	MicroLook	MicroLook BE	Board	SL2	K2C2
Mineralfaser	Ultima	33	87	≤ 0,75(H)	≤ 0,75(H)	≤ 40	A2-s1, d0	95	■ ■ ■	■ ■ ■	■	■ ■ ■	■		■ ■ ■	■ ■ ■
	Ultima OP	30	86	1,00	0,95	26	A2-s1, d0	95	■ ■ ■	■		■				
	Ultima dB	64	87	≤ 0,65(H)	≤ 0,70	≤ 43	A2-s1, d0	95	■ ■ ■	■		■			■ ■ ■	
	Perla	33	86	0,65(H)	0,70	35	A2-s1, d0	95	■ ■ ■	■			■			
	Perla OP	30	86	0,95	0,90	--	A2-s1, d0	95	■ ■ ■	■		■		■ ■ ■	■ ■ ■	
	Perla dB	65	86	≤ 0,60(H)	≤ 0,65	≤ 43	A2-s1, d0	95	■	■			■		■ ■ ■	
	Neeva	--	82	≤ 1,00	≤ 0,95	≤ 27*	A1	95	■ ■ ■	■ ■ ■		■ ■ ■		■ ■ ■		
	Colortone Neeva	--	--	1,00	0,95	24*	A1	95	■ ■ ■							
	Sierra OP	15	83	0,90	0,85	≤ 29	A2-s1, d0	95	■ ■ ■	■		■		■ ■ ■	■ ■ ■	
	Sahara	41	84	0,60	0,55	≤ 39	A2-s1, d0	95	■ ■ ■	■ ■ ■		■ ■ ■	■	■ ■ ■	■ ■ ■	
	Sahara unperforated	41	85	0,10(L)	0,15	34	A2-s1, d0	95	■	■		■				
	Sahara Vector	32	84	0,65	0,65	35	A2-s1, d0	95			■					
	Sahara Max	42	84	0,65	0,65	35	A2-s1, d0	95	■ ■ ■	■		■				
	Sahara dB	62	84	0,60	0,55	39	A2-s1, d0	95	■	■			■			
	Colortone Dune	51	--	0,55	0,55	35*	A2-s1, d0	95	■ ■ ■	■		■				
	Cirrus	33	83	0,55(H)	0,50	36*	A2-s1, d0	95	■	■			■			
	Cirrus Image	33	83	0,55(H)	0,55	36*	A2-s1, d0	70				■				
	Contrast	33	83	0,55	0,50	36*	A2-s1, d0	95				■				
	Plain	≤ 44	87	0,15(L)	0,15	37*	A2-s1, d0	95	■ ■ ■	■		■				
	Graphis	51	92	0,15(L)	0,15	36*	A2-s2, d0	70				■				
Visual	70	--	≤ 0,95	≤ 0,90	--	A2-s1, d0	70				■					
Fine Fissured	≤ 51	85	0,60(H)	0,60	34*	A2-s1, d0	95	■ ■ ■	■		■					
Cortega	≤ 51	82	0,55(H)	0,55	34*	A2-s1, d0	70	■ ■ ■	■							
Tatra	≤ 51	82	0,55(H)	0,55	34*	A2-s1, d0	70	■ ■ ■	■							
Casa	41	85	0,55(H)	0,55	35*	A2-s1, d0	95	■ ■ ■	■							
Metall	Ultra-Mikroperforation	30	83**	0,40(LM)	0,55	18*	A1	95	■ ■ ■ (1)	■ ■ ■	■	■ ■ ■			■ ■ ■ (1) (2)	
	Extra-Mikroperforation	30	80**	0,70***	0,75***	31	A2-s2, d0***	95	■ ■ ■ (1)	■ ■ ■	■	■ ■ ■			■ ■ ■ (1) (2)	
	Mikroperforation	30	65**	1,00***	0,90***	27	A2-s2, d0***	95	■ ■ ■ (1)	■ ■ ■	■	■ ■ ■			■ ■ ■ (1) (2)	
	Standardperforation	30	70**	0,95***	0,90***	28	A2-s2, d0***	95	■ ■ ■ (1)	■ ■ ■	■	■ ■ ■			■ ■ ■ (1) (2)	
	Unperforiert (ISO 3)	30	85**	0,10(L)	0,10	44*	A1	95	■ ■ ■ (1)	■ ■ ■	■	■ ■ ■			■ ■ ■ (1) (2)	
Holz	Madera Furnier	--	≤ 60	≤ 0,50(L)	≤ 0,60	--	B-s2, d0	70			■	■				■
	Madera Laminiert	--	≤ 75	≤ 0,50(L)	≤ 0,60	--	B-s2, d0	70			■	■				■

■ 600 x 600 mm oder äquivalent. ■ 600 x 1200 mm, 300 x 1200 mm oder äquivalent. ■ Langfeldplatten, 300 x 1500/1800/2500 mm oder äquivalent.

*Dncw Leistung. ** RAL 9010. *** Baustoffklasse für Produkte versehen mit Premium OP 19. Weitere Akustiklösungen finden Sie in unserer Metallbroschüre.

(1) Gleiche Abmessung für die Clip-in Produktreihe. (2) HOOK-ON Metallangfeldplatten.

Aktuelle Informationen finden Sie unter www.armstrong-decken.de

Laminiert...

ULTIMA



Ultima,
Ultima OP,
Ultima dB

PERLA & NEEVA



Perla,
Perla OP,
Perla dB,
Neeva

COLORTONE NEEVA

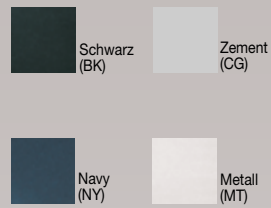

SIERRA OP



Feinstrukturiert...

DUNE

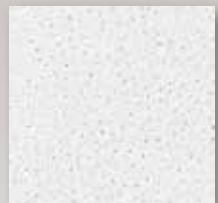

Sahara,
Sahara Max,
Sahara dB

DUNE UNPERFORIERT



Sahara
Unperforiert

COLORTONE DUNE



CIRRUS

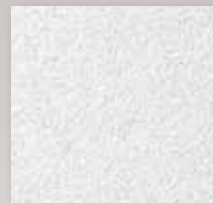

Cirrus

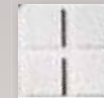

Cirrus
Image

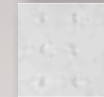

Contrast
Square



Contrast
Circles

Glatt...

PLAIN

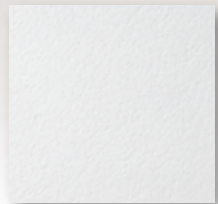

Plain

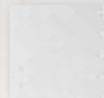

Graphis
Puntos

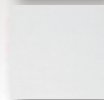

Graphis
Linear



Graphis
Cuadros



Graphis
Neocubic

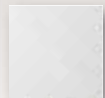

Graphis
Diagonal



Graphis
Mix A & B

Offenes Zellenraster...

VISUAL V49 & V64

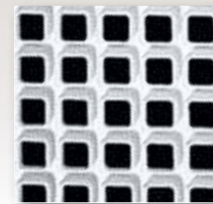

Fissuriert...

FINE FISSURED



Fine Fissured

CORTEGA



TATRA



Perforiert...

CASA

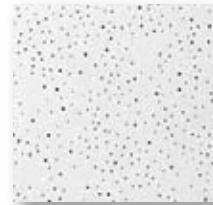

Oberfläche...

UNPERFORIERT

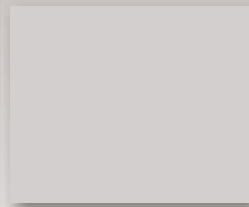

ULTRA-MIKROPERFORATION

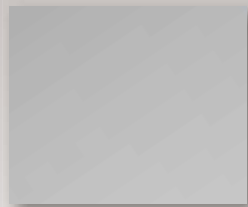

EXTRA-MIKROPERFORATION

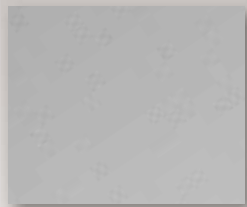

MIKROPERFORATION



STANDARDPERFORATION

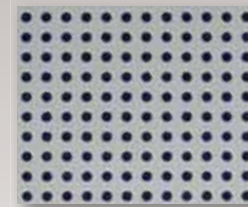

OFFENES ZELLENRASTER / Cellio



Systeme...

CLIP-IN

Q-Clip, R-Clip, T-Clip, S-Clip



LAY-IN

Axal Vector



LAY-IN

Board



LAY-IN

Tegular 2, 8, 11F, 16



LAY-IN

MicroLook 8, 16



HOOK-ON

R-H 200, R-H 215



Madera laminiert...

AHORN (CM)



LINDE (LM)



BIRNE (PH)



Madera - holzfurnier...

BUCHE (BH)



US KIRSCHKE (UC)



US AHORN (UM)

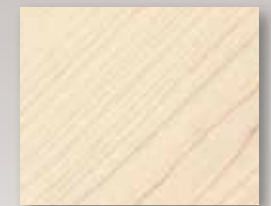

Perforationen...

A1

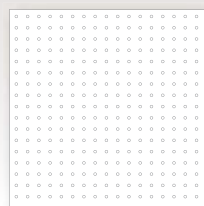

A2

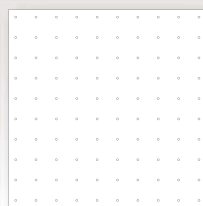

A8

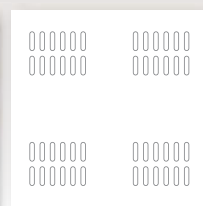

A10

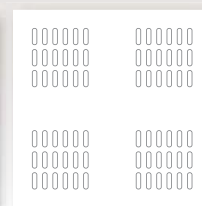

A12



Spezielle Einsatzbereiche

ISO...

BIOGUARD

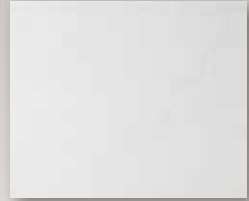

Plain

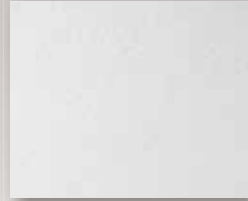

Acoustic



Metall

CLEAN ROOM FL



PARAFON HYGIEN

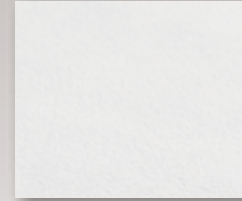

CLEAN ROOM
UNTERKONSTRUKTION

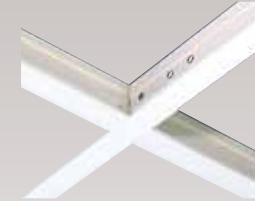

RH...

HYDROBOARD

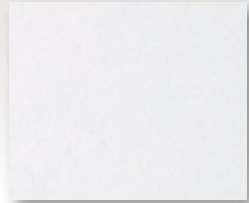

NEWTONE



CERAMAGUARD



KORROSIONSBESTÄNDIGE
UNTERKONSTRUKTION

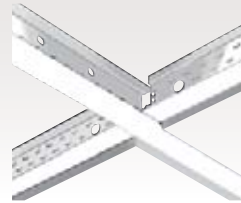

Spezielle Einsatzbereiche

Unterkonstruktionssysteme

AXIOM PROFILE
AXIOM TRANSITION



INTERLUDE 15 mm
XL²



SILHOUETTE 15 mm
XL²



PRELUDE 15 mm
XL² / TL



PRELUDE 24 mm
XL² / TLX



PRELUDE SIXTY² 24 mm
XL² / TLX



PRELUDE 35 mm
XL²



BANDRASTER



Z PROFILE

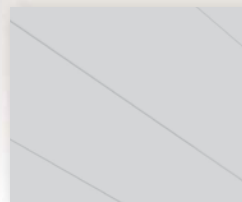

KORROSIONSBESTÄNDIG
24 mm



CLEAN ROOM
24 mm



Unterkonstruktionssysteme

Mineralfaser...

ULTIMA CANOPY-DECKENSEGEL



Konvex

ULTIMA CANOPY-DECKENSEGEL



Konkav

Metall...

METALL CANOPY-DECKENSEGEL



Konkav, konvex oder flach

D-H 700 / D-CLIP



Axiom...

AXIOM C CANOPY-DECKENSEGEL



AXIOM KE CANOPY-DECKENSEGEL



Produktvorschlag...

- Offene Bereiche, Bibliothek, Lounge
- Konzentration -
 - OP Palette: Ultima, Perla, Sierra
 - Neeva
 - Ultima Canopy-Deckensegel
- Konferenzräume, Klassenräume
- Sprachverständlichkeit -
 - Ultima, Perla, Sahara Max
- Einzelbüro, Patientenzimmer
- Vertraulichkeit -
 - dB Palette: Ultima, Perla, Sahara
 - Metall Premium B15
- Flurbereiche
- Zugänglichkeit -
 - Langfeldplatten aus Mineralfaser & Metall, Korridordecken
 - Canopy Palette: Mineralfaser, Metall & Holz
- Kantinen, Restaurant
- Akustischer Komfort: (leise) -
 - OP Palette: Ultima, Perla, Sierra
 - Neeva
 - Ultima Canopy-Deckensegel
- Empfang- & Eingangsbereiche
- Design -
 - Canopy Palette: Mineralfaser, Metall & Holz
- Küche
- Hygiene (ISO) -
 - Bioguard Palette (Mineralfaser & Metall) & Clean Room Unterkonstruktion
- Naßbereiche
- Relative Luftfeuchtebeständigkeit (100% RH) -
 - Ceramaguard, Newtonone, Hydroboard

Eine große Auswahl an **Broschüren...**



Technische Datenblätter

Segmentbroschüre

Unsere Website...

www.armstrong-decken.de

Größe und Art, Form, Abmessungen, Anwendungen, akustische Lösungen ... Wählen Sie nach Ihren Bedürfnissen: Mit der erneuten Website können Armstrong Deckenlösungen Ihre Anforderungen erfüllen.

